

Fuel oil/gas boilers

PK 350 - PK 450 - PK 550

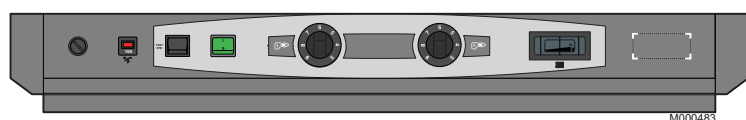

User Guide

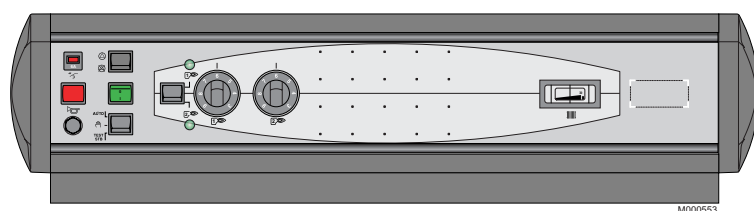

Contents

1	Introduction	3
1.1	Symbols and abbreviations	3
1.2	General	3
2	Safety instructions and recommendations	4
2.1	Safety instructions	4
2.2	Recommendations	4
3	Description	5
3.1	General description	5
3.2	Boiler	6
3.3	Description of the S3 control panel	7
3.4	Description of the R control panel	8
4	Changing the settings	9
5	Start the boiler	10
6	Switching off the central heating	12
6.1	Stop	12
6.2	Prolonged absence	12
7	Checking and maintenance	13
7.1	Checks	13
7.2	Hydraulic pressure	13
7.3	Draining	13
7.4	Maintenance	13
8	Troubleshooting	14
8.1	Type plate	14
8.2	Incidents and solutions	15
9	Energy savings	16

1 Introduction

1.1 Symbols and abbreviations

In these instructions, various markings and pictograms are used to draw your attention to particular information. In so doing, OERTLI THERMIQUE S.A.S. wishes to safeguard the user's safety, obviate hazards and guarantee correct operation of the boiler.

 **Danger**
Risk of a dangerous situation causing serious physical injury.

 **Warning**
Risk of a dangerous situation causing slight physical injury.

 **Caution**
Risk of material damage.



 Specific information.

 Reference
Refer to another manual or other pages in this instruction manual.

▶ **DHW:** Domestic hot water.

1.2 General

1.2.1 Manufacturer's liability

OERTLI THERMIQUE S.A.S. manufactures products in compliance with the standard . Products are delivered with  marking and all documents required.

In the interest of customers, OERTLI THERMIQUE S.A.S. are continuously endeavouring to make improvements in product quality. All the specifications stated in this document are therefore subject to change without notice.

The liability of OERTLI THERMIQUE S.A.S. as the manufacturer may not be invoked in the following cases:

- ▶ Failure to abide by the instructions on using the appliance.
- ▶ Faulty or insufficient maintenance of the appliance.
- ▶ Failure to abide by the instructions on installing the appliance.

1.2.2 Installer's liability

The installer is responsible for the installation and commissioning of the appliance. The installer must respect the following instructions:

- ▶ Read and follow the instructions given in the manuals provided with the appliance.
- ▶ Carry out installation in compliance with the prevailing legislation and standards.

- ▶ Perform the initial start up and carry out any checks necessary.
- ▶ Explain the installation to the user.
- ▶ If a maintenance is necessary, warn the user of the obligation to check the appliance and maintain it in good working order.
- ▶ Give all the instruction manuals to the user.

1.2.3 User's liability

To guarantee optimum operation of the appliance, the user must respect the following instructions:

- ▶ Read and abide by the instructions given in the user manual.
- ▶ Call on qualified professionals to carry out installation and initial start up.
- ▶ Get your installer to explain your installation to you.
- ▶ Ensure the Appliance is serviced in accordance with the manufacturer's instructions by a suitable qualified person.
- ▶ Keep the instruction manuals in good condition close to the appliance.

2 Safety instructions and recommendations



2.1 Safety instructions

 For a proper operating of the boiler, follow carefully the instructions.

 Only qualified professionals are authorised to work on the appliance and the installation.

 Incorrect use or unauthorised modifications to the installation or the equipment itself invalidate any right to claim.

 Before any work, switch off the mains supply to the appliance.

 Keep to the polarity shown on the terminals: phase (L), neutral (N) and earth .

 Keep children away from the boiler.

■ Fire hazard

 It is forbidden to store inflammable products and materials in the boiler room or close to the boiler, even temporarily.

■ Risk of intoxication

 Do not obstruct the air inlets in the room (even partially).

 If you smell flue gases

1. Switch the appliance off
2. Open the windows
3. Evacuate the premises
4. Contact a qualified professional

■ Risk of being burnt

 Depending on the settings of the appliance:

- The temperature of the flue gas conduits may exceed 180°C
- The temperature of the radiators may reach 95°C
- The temperature of the domestic hot water may reach 65°C

■ Risk of damage

 Do not stock chloride or fluoride compounds close to the appliance.

 Install the appliance in premises sheltered from rain, snow and frost.

 Do not neglect to service the appliance: Contact a qualified professional or take out a maintenance contract for the annual servicing of the appliance.

2.2 Recommendations

- Check regularly that the installation contains water and is pressurised.
- Keep the appliance accessible at all times.
- Avoid draining the installation.
- Use only original spare parts.
- Never remove or cover labels and rating plates affixed to the appliance.

3 Description

3.1 General description

PK 350 - PK 450 - PK 550 boilers are intended for central heating using radiators or underfloor heating. These boilers have the following characteristics:

- Hot-water boiler
- Heating body in cast iron,
- Pressurised boiler,

- Boiler to be fitted with a gas or oil pressure jet burner
- **S3** or **R** control panel (See below)
- Production of domestic hot water can be ensured by a separate hot water calorifier.
- Connecting to a chimney

■ Standard control panel - S3

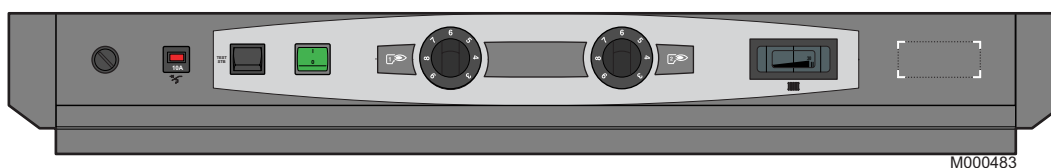

Standard panel to be fitted

Panel comprising the settings, control and safety devices allowing the boiler to operate autonomously, without regulation.

The standard panel is used to connect the boiler to the boiler room control cabinet.

This cabinet can be fitted with control units.

■ R control panel

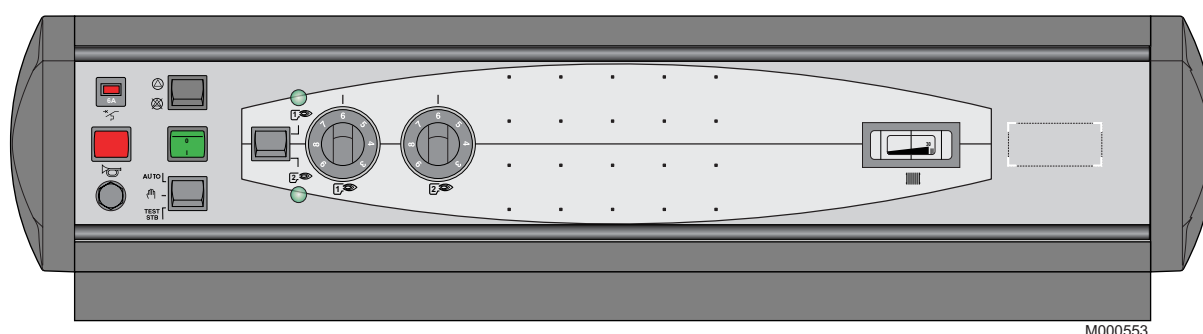

Separate panel

The control panel enables the operation of a boiler fitted with a 1 stage, 2 stage or modulating burner.

Control system based on outside temperature if a regulator has been installed (see options).

3.2 Boiler

■ PK 350



■ PK 550



■ PK 450



 Refer to the installation and maintenance instructions of the boiler.

3.3 Description of the S3 control panel

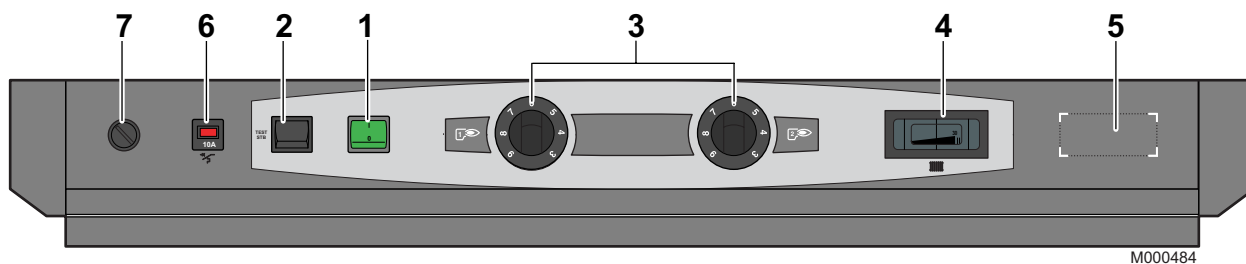

1. **General ON (1) / OFF (0) switch**
2. **Switch Test-STB**
3. **Boiler thermostats (30 to 85 °C)**
4. **Boiler thermometer, Boiler temperature display**
5. **Location for flue gas thermometer (optional)**
6. **Timed circuit breaker (6 A) with delayed action and manual reset**
7. **Safety thermostat with manual reset**

(set to 110 °C)

The safety thermostat with manual reset ensures that the boiler operates safely.

⚠ In the event that there is an abnormal rise in the temperature in the boiler 110° C. Advise your installation engineer.

3.4 Description of the R control panel

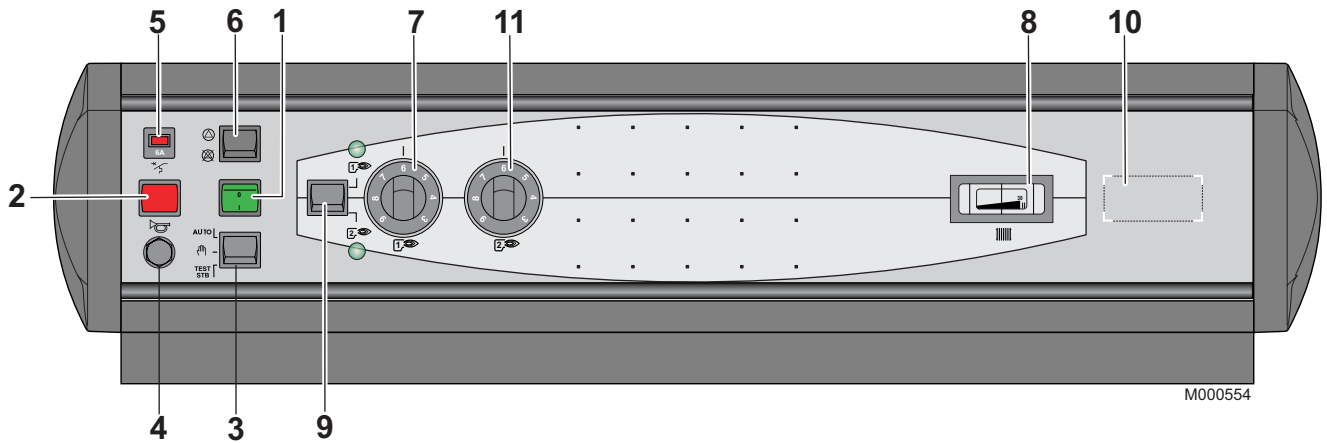

1. **General ON (1) / OFF (0) switch**
2. **Burner alarm indicator**
This indicator lights up when the burner is on safety (failure).
3. **Switch AUTO/Manual/TEST-STB**
Position **AUTO**: This position enables automatic operation of the installation in accordance with regulation controls, room thermostat and DHW module.
Position **Manual**: The boiler no longer takes orders from the regulation into account. The boiler is regulated by the boiler thermostat(s).
Position **TEST-STB**: Temporary action to test the safety thermostat.
4. **Safety thermostat with manual reset**
Set to 110° C
5. **Timed circuit breaker (10 A) with delayed action and manual reset**
6. **Pump shutdown switch**
7. **Stage 1 boiler thermostat (30 to 85 °C)**
A factory-set stop limits the maximum temperature to 75 °C. The stop may be moved if necessary (See "Moving the thermostat stop").
8. **Boiler thermometer, Boiler temperature display**
9. **Switch for selecting the number of burner stages**
10. **Location for flue gas thermometer (optional)**
11. **Stage 2 boiler thermostat (30 to 85 °C)**
A factory-set stop limits the maximum temperature to 75 °C. The stop may be moved if necessary (See "Moving the thermostat stop").

4 Changing the settings

To change the temperature of the heating water or to change the programming:

- ▶ Refer to the connection instructions supplied with the control panel.
- ▶ Refer to the description of the installation

5 Start the boiler

- ▶ Check the water pressure in the installation. The hydraulic pressure must be a minimum of 0.8 bars. Adjust the pressure if necessary, avoiding a sudden influx of cold water into the boiler when it is hot.

0.8...1.5 bar



- ▶ Switch on the appliance
- ▶ Open the valves on the heating circuit

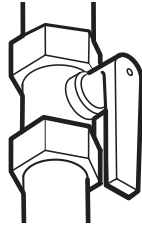

- ▶ Open the fuel supply
- ▶ Provoke a heating request: see below (depending on the type of control panel).

■ S3 control panel

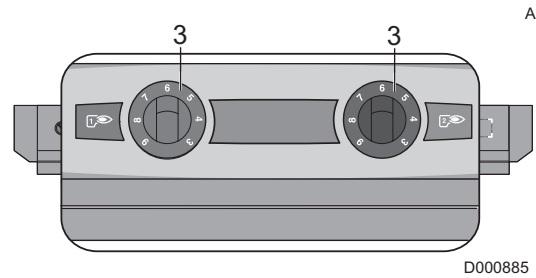

- ▶ Set the boiler thermostats **3** to the desired position. The 2nd stage thermostat must be set to a value at least 5°C lower than the 1st stage thermostat.

⚠ If there is no control unit, we advise you never to set the boiler thermostat below mark 4 (approx. 40°C) in order to avoid the risk of combustion products condensing on the walls of the boiler.

▶ Control unit in boiler room electrical cabinet:

- See the instructions supplied with the control unit and any remote control unit used.

▶ Set main On/Off switch 1 to I.

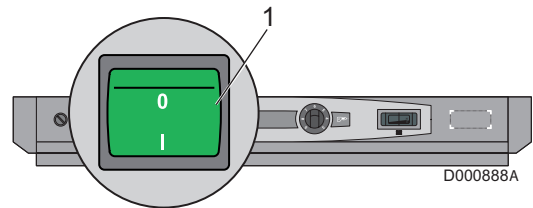

- ▶ The boiler starts to operate.

■ R control panel

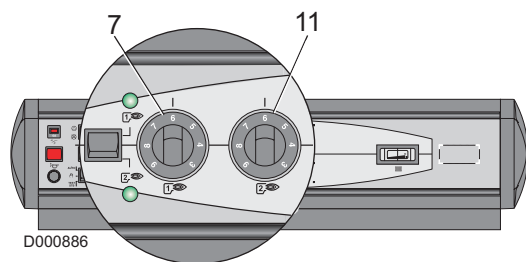

- Place the boiler thermostat 7 in the required position.
- When preparing domestic hot water, Place thermostat 11 on the required setting. Setting 6 (approx 60° C) recommended.

This value must always be below the temperature limiter for the domestic hot water load.

- Set main On/Off switch 1 to I.

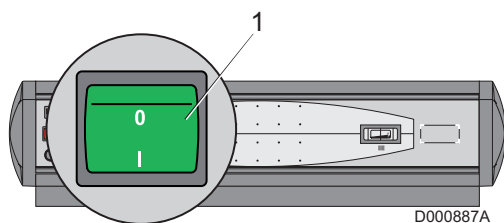

- The boiler starts to operate.

 See:

- Control panel instructions
- Burner instructions
- Domestic hot water calorifier instructions

6 Switching off the central heating

6.1 Stop

1. Set the On/Off switch to **O**.
2. Switch off the boiler electrical power supply
3. Close the fuel supply.

 See: Control panel instructions

 See: Burner instructions

■ S3 control panel

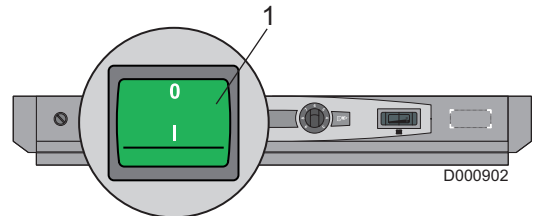

■ R control panel

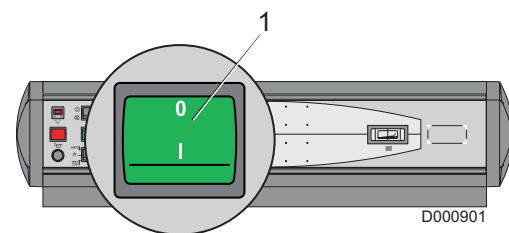

6.2 Prolonged absence

6.2.1 Precautions required in the case of long boiler stops

- The boiler and the chimney must be swept carefully.
- Close all the doors of the boiler to prevent air from circulating inside the boiler.
- We advise removing the pipe which connects the boiler to the chimney and to close off the nozzle with a cover.

6.2.2 Precautions required if the heating is stopped when there is a risk of freezing

We recommend the use of a correctly dosed antifreeze agent to prevent the heating circuit from freezing.

If this cannot be done, drain the system completely.

7 Checking and maintenance

7.1 Checks

Make the following checks at least 1 time a year:

- Safety devices
- System pressure
- Checking burner safety
- Checking the safety thermostat
- Condensates neutralisation system

Carry out the following maintenance at least 1 time a year:

- Cleaning the burner
- Cleaning of the heating body
- Cleaning of the condenser
- Cleaning the siphon
- Cleaning the flue gas circuit

7.2 Hydraulic pressure

Checking the hydraulic pressure. The hydraulic pressure must be a minimum of 0.8 bars. Adjust the pressure if necessary, avoiding a sudden influx of cold water into the boiler when it is hot.

This operation should be required only a few times in each heating season, with very low quantities of water; otherwise, look for the leak and repair it.

0.8...1.5 bar

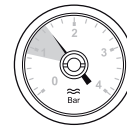

D000903

7.3 Draining

We advise you against draining the system unless it is absolutely necessary.

7.4 Maintenance

⚠ The boiler will only operate efficiently if the exchange surfaces are kept clean.

Ensure the Appliance is serviced in accordance with the manufacturer's instructions by a suitable qualified person.

- ▶ The boiler must be serviced and fully cleaned and the flue gas conduit swept by a qualified professional at least 1 times per year.

8 Troubleshooting

- ▶ Carry out the checks mentioned in the burner instructions.
- ▶ Contact a qualified professional

8.1 Type plate

i Before informing the fitter of a fault, make a note of the following information:

1. The type of control panel,
2. Boiler rating plate:
 - Boiler type
 - Serial no. of the appliance
 - Manufacturing date
3. Burner rating plate:
 - Burner type
 - Type of combustible
 - Burner serial number
 - Manufacturing date

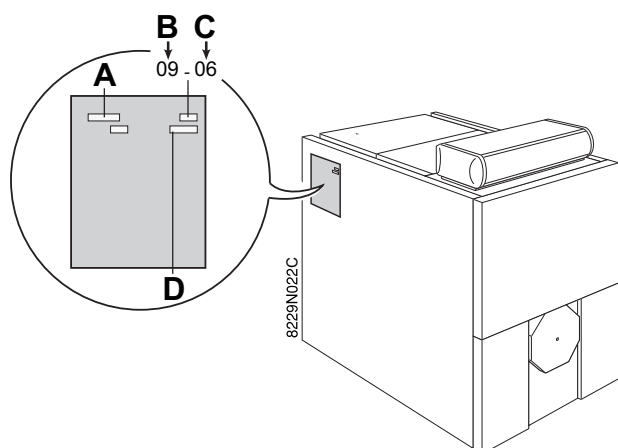

- A Boiler type
- B Year
- C Week
- D Serial no. of the appliance

8.2 Incidents and solutions

■ The burner is not working:

- ▶ Check the boiler thermostat settings.
- ▶ Carry out the checks mentioned in the burner instructions.
- ▶ Shutdown by the safety thermostat due to accidental overheating:

Check that the safety thermostat has not triggered. To restart the boiler, reset the safety thermostat. Remove the safety thermostat hood and press the reset button with a screwdriver.

- Standard control panel

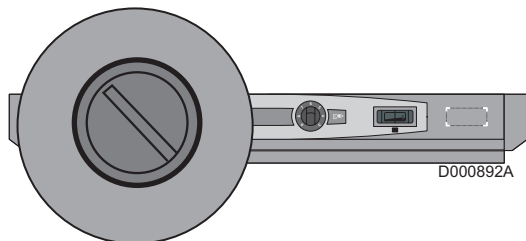

- R control panel

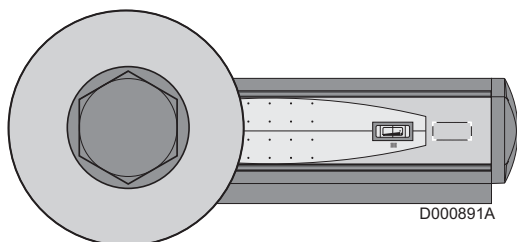

- ▶ Carry out the start-up operations again. Call your fitter.
- ▶ Check the circuit breaker
- Standard control panel

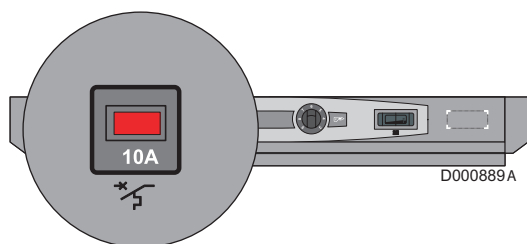

- R control panel

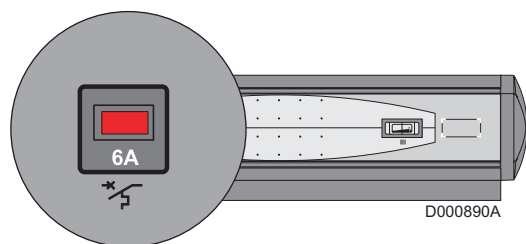

■ The burner is operating but the radiators are cold:

- ▶ Bleed the radiators.

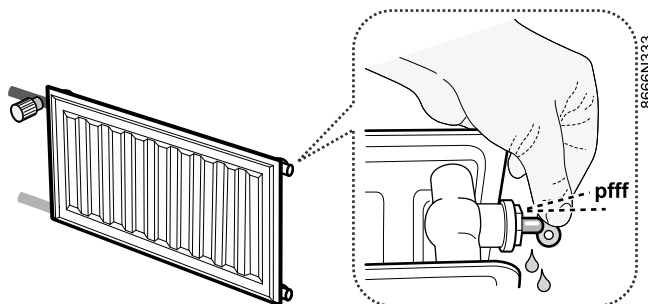

- ▶ Checking the hydraulic pressure. The hydraulic pressure must be a minimum of 0.8 bars. Adjust the pressure if necessary, avoiding a sudden influx of cold water into the boiler when it is hot. If it is often necessary to top up the installation with water, contact your fitter.

0.8...1.5 bar



- ▶ Check that the heating pumps are working correctly
- ▶ Check the settings on the boiler thermostat(s).

 See page: 7-8.

9 Energy savings

Here are a few tips for saving energy:

- Install reflector panels behind the radiators.
- Do not cover the radiators. Do not hang curtains in front of the radiators.
- Insulate pipes to prevent thermal losses and condensation.
- Do not obstruct aeration grates (even partially). They help to reduce humidity in the home. The more humid a home, the more heating it consumes.
- Turn heating off when airing a room (5 minutes a day is sufficient) Avoid deregulating the thermostat. Switch the On/Off switch to Off.
- Do not shut down heating completely if you are absent. Lower the thermostat by 3-4°C.
- Use the sun's heat as much as possible.
- Take showers rather than baths. Use a water-saving shower head.

Warranty

You have just purchased one of our appliances and we thank you for the trust you have placed in our products. Please note that your appliance will provide good service for a longer period of time if it is regularly checked and maintained. Your fitter and our customer support network are at your disposal at all times.

■ Warranty terms

Starting from the purchase date shown on the original fitter's invoice, your appliance has a contractual guarantee against any manufacturing defect.

The length of the guarantee is mentioned in the price catalogue.

The manufacturer is not liable for any improper use of the appliance or failure to maintain or install the unit correctly (the user shall take care to ensure that the system is installed by a qualified fitter). In particular, the manufacturer shall not be held responsible for any damage, loss or injury caused by installations which do not comply with the following:

- applicable local laws and regulations
- specific requirements relating to the installation, such as national and/or local regulations
- the manufacturer's instructions, in particular those relating to the regular maintenance of the unit
- the rules of the profession

The warranty is limited to the exchange or repair of such parts as have been recognised to be faulty by our technical department and does not cover labour, travel and carriage costs. The warranty shall not apply to the replacement or repair of parts damaged by normal wear and tear, negligence, repairs by unqualified parties, faulty or insufficient monitoring and maintenance, faulty power supply or the use of unsuitable fuel. Sub-assemblies such as motors, pumps, electric valves etc. are guaranteed only if they have never been dismantled.

■ France

The preceding dispositions are not exclusive of benefits for the purchaser of the legal guarantee as stated in Civil Code articles 1641 to 1648.

■ Poland

Warranty conditions are included in the warranty card.

■ Switzerland

The application of the warranty is subject to the terms and conditions of sale, delivery and warranty of the company marketing our products.

■ Belgium

The preceding dispositions about the contractual guarantee are not exclusive of profit if the need arises for the purchaser in Belgium of the applicable legal dispositions on hidden defects.

■ Italy

The duration of our warranty is shown on the certificate delivered with the appliance.

Our liability as manufacturer may not be invoked in respect of incorrect use of the appliance, incorrect or insufficient maintenance thereof, or incorrect installation of the appliance (you must therefore ensure that installation and maintenance operations are carried out respectively by a qualified professional and by an after sales service company).

The legislation laid down by European Directive 99/44/EEC, transposed by Legislative Decree No. 24 of 2 February 2002 published in O.J. No. 57 of 8 March 2002, continues to apply.

■ Russia

The foregoing provisions in no way affect the rights of the consumer, which are guaranteed by the legislation of the Russian Federation as regards hidden defects.

The terms and conditions of warranty and the terms and conditions of application of the warranty are indicated on the warranty form.

The warranty shall not apply as regards the replacement or repair of wearing parts under normal use. Such parts include thermocouples, injection nozzles, flame control and ignition systems, fuses and gaskets.

■ Turkey

Due to the laws and regulations the product life for this product is 10 years. During that time the producer and/or the distributor has to provide after sales services and spare parts.

■ Other countries

The above provisions do not restrict the benefit of the legal laws regarding hidden defects applicable in the buyer's country.

OERTLI THERMIQUE S.A.S.



Direction des Ventes France
Z.I. de Vieux-Thann
2, avenue Josué Heilmann • B.P. 50018
F-68801 Thann Cedex

www.oertli.fr

Assistance Technique PRO

N° Indigo 0 825 825 636
0,15 € TTC / MN

☎ 03 89 37 69 35

✉ assistance.technique@oertli.fr

OERTLI ROHLEDER WÄRMETECHNIK GmbH



Raiffeisenstraße 3
D-71696 MÖGLINGEN

☎ 07141 24 54 0 (Zentrale)

☎ 07141 24 54 40 (Ersatzteilwesen)

☎ 07141 24 54 88

✉ info@oertli.de

www.oertli.de

REMEHA NV/SA



Koralenhoeve 10
B-2160 WOMMELGEM

☎ +32 (0)3 230 71 06

☎ +32 (0)3 354 54 30

✉ info@remeha.be

www.remeha.be

WALTER MEIER (Klima Schweiz) AG WALTER MEIER (Climat Suisse) S.A.



Bahnstrasse 24
CH-8603 SCHWERZENBACH

☎ +41 (0) 44 806 44 24

ServiceLine +41 (0) 800 846 846

☎ +41 (0) 44 806 44 25

✉ ch.klima@waltermeier.com

www.waltermeier.com

Z.I. de la Veyre, St-Légier
CH-1800 VEVEY 1

☎ +41 (0) 21 943 02 22

ServiceLine +41 (0) 800 846 846

☎ +41 (0) 21 943 02 33

✉ ch.climat@waltermeier.com

www.waltermeier.com

© Copyright

All technical and technological information contained in these technical instructions, as well as any drawings and technical descriptions supplied, remain our property and shall not be multiplied without our prior consent in writing.

Subject to alterations.

16/03/2016



300019443-001-02

OERTLI THERMIQUE S.A.S.

Z.I. de Vieux-Thann
2, avenue Josué Heilmann • B.P. 50018
F-68801 Thann Cedex